

RECOMMENDATIONS AND SUGGESTIONS

INSTALLATION

- The manufacturer will not be held liable for any damages resulting from incorrect or improper installation.
- The minimum safety distance between the cooker top and the extractor hood is 650 mm.
- Check that the mains voltage corresponds to that indicated on the rating plate fixed to the inside of the hood.
- For Class I appliances, check that the domestic power supply guarantees adequate earthing.

Connect the extractor to the exhaust flue through a pipe of minimum diameter 120 mm. The route of the flue must be as short as possible.

- Do not connect the extractor hood to exhaust ducts carrying combustion fumes (boilers, fireplaces, etc.).
- If the extractor is used in conjunction with non-electrical appliances (e.g. gas burning appliances), a sufficient degree of aeration must be guaranteed in the room in order to prevent the backflow of exhaust gas. The kitchen must have an opening communicating directly with the open air in order to guarantee the entry of clean air.

USE

- The extractor hood has been designed exclusively for domestic use to eliminate kitchen smells.
- Never use the hood for purposes other than for which it has been designed.
- Never leave high naked flames under the hood when it is in operation.
- Adjust the flame intensity to direct it onto the bottom of the pan only, making sure that it does not engulf the sides.
- Deep fat fryers must be continuously monitored during use: overheated oil can burst into flames.
- The hood should not be used by children or persons not instructed in its correct use.

MAINTENANCE

- Switch off or unplug the appliance from the mains supply before carrying out any maintenance work.
- Clean and/or replace the Filters after the specified time period.
- Clean the hood using a damp cloth and a neutral liquid detergent.

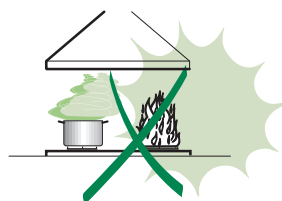
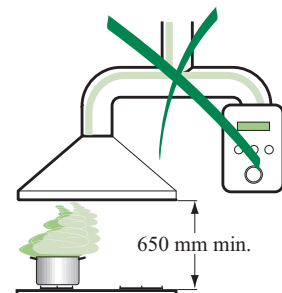
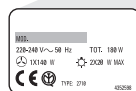
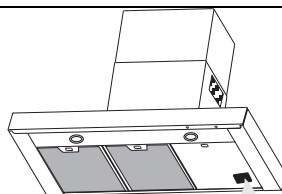

CHARACTERISTICS

Dimensions

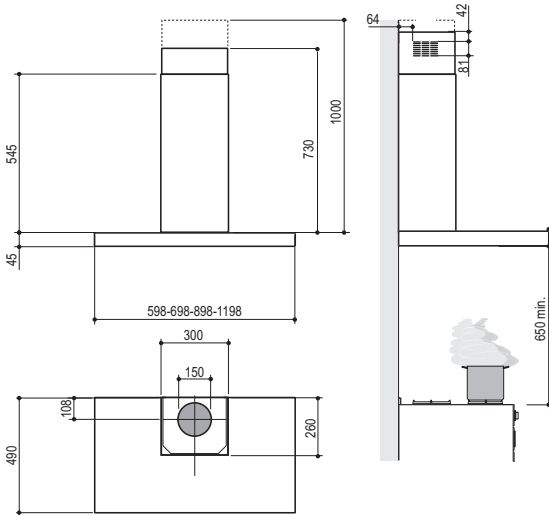

Components

Ref.	Q.ty	Product Components
1	1	Hood Body, complete with: Controls, Light, Blower, Filters
2	1	Telescopic Chimney comprising:
2.1	1	Upper Section
2.2	1	Lower Section
9	1	Reducer Flange \varnothing 150-120 mm
14.1	2	Air Outlet Connection Extension
15	1	Air Outlet Connection

Ref.	Q.ty	Installation Components
7.2.1	2	Upper Chimney Section Fixing Brackets
7.3	1	Air Outlet Connection Support
11	6	Wall Plugs
12a	6	Screws 4,2 x 44,4
12c	6	Screws 2,9 x 9,5
Q.ty	Documentation	
1	Instruction Manual	

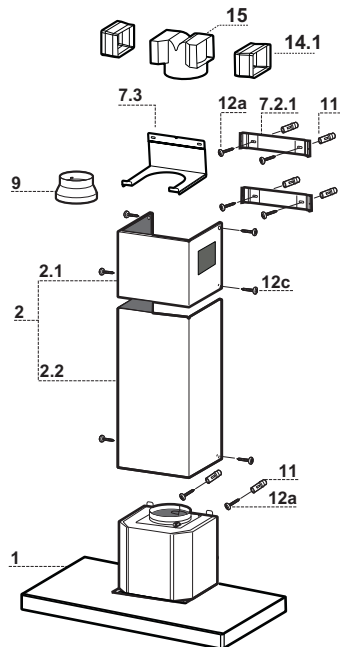

INSTALLATION

Wall drilling and bracket fixing

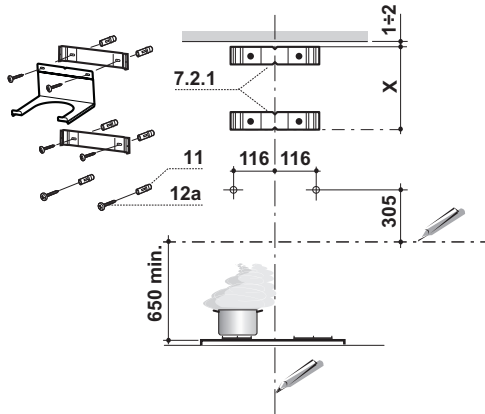

Wall marking:

- Draw a vertical line on the supporting wall up to the ceiling, or as high as practical, at the centre of the area in which the hood will be installed.
- Draw a horizontal line at 650 mm above the hob.
- Place bracket **7.2.1** on the wall as shown about 1-2 mm from the ceiling or upper limit aligning the centre (notch) with the vertical reference line.
- Mark the wall at the centres of the holes in the bracket.
- Place bracket **7.2.1** on the wall as shown at X mm below the first bracket (X = height of the upper chimney section supplied), aligning the centre (notch) with the vertical line.
- Mark the wall at the centres of the holes in the bracket.
- Mark a reference point as indicated at 116 mm from the vertical reference line and 305 mm above the horizontal reference line.
- Repeat this operation on the other side.
- Drill \varnothing 8 mm holes at all the centre points marked.
- Insert the wall plugs **11** in the holes.
- Fix the lower bracket **7.2.1** using the **12a** screws (4,2 x 44,4) supplied.
- Fix the upper bracket **7.2.1** and the air outlet connection support **7.3** together using the 2 screws **12a** (4,2 x 44,4) supplied.
- Insert the two screws **12a** (4,2 x 44,4) supplied in the hood body fixing holes, leaving a gap of 5-6 mm between the wall and the head of the screw.

Mounting the hood body

- Before attaching the hood body, tighten the two screws **Vr** located on the hood body mounting points.
- Hook the hood body onto the screws **12a**.
- Fully tighten support screws **12a**.
- Adjust screws **Vr** to level the hood body.

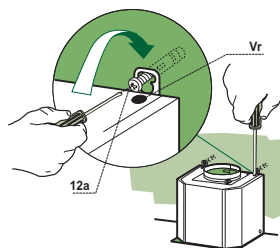

Connections

DUCTED VERSION AIR EXHAUST SYSTEM

When installing the ducted version, connect the hood to the chimney using either a flexible or rigid pipe $\varnothing 150$ or 120 mm, the choice of which is left to the installer.

- To install a $\varnothing 120$ mm air exhaust connection, insert the reducer flange **9** on the hood body outlet.
- Fix the pipe in position using sufficient pipe clamps (not supplied).
- Remove any activated charcoal filters.

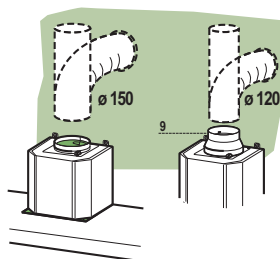

RECIRCULATION VERSION AIR OUTLET

- Put connection **15** into the connection support **7.3**.
- Insert the connection extension pieces laterally **14.1** in connection **15**.
- Make sure that the outlet of the extension pieces **14.1** is horizontally and vertically aligned with the chimney outlets.
- Connect the air outlet connection **15** to the hood body outlet using either a flexible or rigid pipe $\varnothing 150$ mm, the choice of which is left to the installer.
- Ensure that the activated charcoal filters have been inserted.

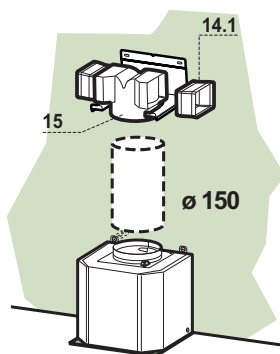

ELECTRICAL CONNECTION

- Connect the hood to the mains through a two-pole switch having a contact gap of at least 3 mm.
- Remove the grease filters (see paragraph Maintenance) being sure that the connector of the feeding cable is correctly inserted in the socket placed on the side of the fan.

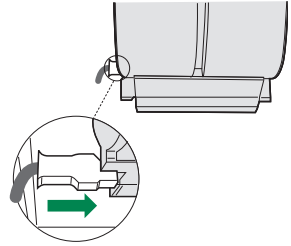

Flue assembly

Upper exhaust flue

- Slightly widen the two sides of the upper flue and hook them behind the brackets **7.2.1**, making sure that they are well seated.
- Secure the sides to the brackets using the 4 screws **12c** (2,9 x 9,5) supplied.
- Make sure that the outlet of the extensions pieces is aligned with the chimney outlets.

Lower exhaust flue

- Slightly widen the two sides of the flue and hook them between the upper flue and the wall, making sure that they are well seated.
- Fix the lower part laterally to the hood body using the 2 screws **12c** (2,9 x 9,5) supplied.

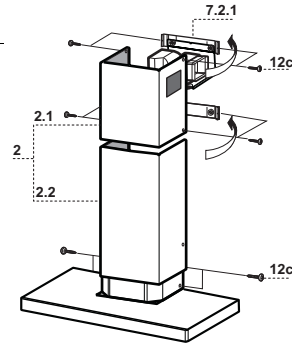

USE

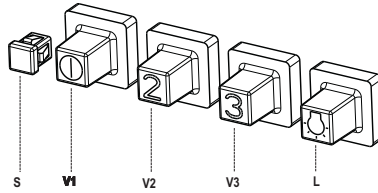

L	Light	Switches the lighting system on and off.
S	Led	Motor running led.
V1	Motor	Switches the extractor motor on and off at low speed. Used to provide a continuous and silent air change in the presence of light cooking vapours.
V2	Speed	Medium speed, suitable for most operating conditions given the optimum treated air flow/noise level ratio.
V3	Intensive	Maximum speed, used for eliminating the highest cooking vapour emission, including long periods.

MAINTENANCE

Grease filters

CLEANING METAL SELF- SUPPORTING GREASE FILTERS

- The filters must be cleaned every 2 months of operation, or more frequently for particularly heavy usage, and can be washed in a dishwasher.
- Remove the filters one at a time holding them up with one hand and pulling the handle downwards with the other hand at the same time.
- Wash the filters, taking care not to bend them. Allow them to dry before refitting.
- When refitting the filters, make sure that the handle is visible on the outside.

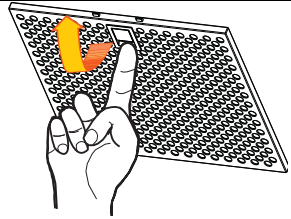

Activated charcoal filter (Recirculation version)

REPLACING THE ACTIVATED CHARCOAL FILTER

- The filter is not washable and cannot be regenerated, and must be replaced approximately every 4 months of operation, or more frequently for particularly heavy usage.
- Remove the metal grease filters
- Remove the saturated activated carbon filter by releasing the fixing hooks
- Fit the new filter by hooking it into its seating
- Replace the metal grease filters.

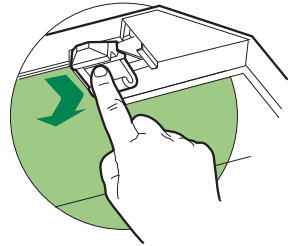

Lighting

LIGHT REPLACEMENT

20 W halogen light.

- Remove the snap-on lamp cover by levering it from under the metal ring, supporting it with one hand.
- Remove the halogen lamp from the lamp holder by pulling gently.
- Replace the lamp with a new one of the same type, making sure that you insert the two pins properly into the housings on the lamp holder.
- Replace the snap-on lamp cover.

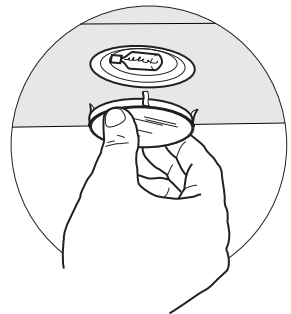



Il simbolo  sul prodotto o sulla confezione indica che il prodotto non deve essere considerato come un normale rifiuto domestico, ma deve essere portato nel punto di raccolta appropriato per il riciclaggio di apparecchiature elettriche ed elettroniche. Provvedendo a smaltire questo prodotto in modo appropriato, si contribuisce a evitare potenziali conseguenze negative per l'ambiente e per la salute, che potrebbero derivare da uno smaltimento inadeguato del prodotto. Per informazioni più dettagliate sul riciclaggio di questo prodotto, contattare l'ufficio comunale, il servizio locale di smaltimento rifiuti o il negozio in cui è stato acquistato il prodotto.



The symbol  on the product or on its packaging indicates that this product may not be treated as household waste. Instead it shall be handed over to the applicable collection point for the recycling of electrical and electronic equipment. By ensuring this product is disposed of correctly, you will help prevent potential negative consequences for the environment and human health, which could otherwise be caused by inappropriate waste handling of this product. For more detailed information about recycling of this product, please contact your local city office, your household waste disposal service or the shop where you purchased the product.



Le symbole  sur le produit ou son emballage indique que ce produit ne peut être traité comme déchet ménager. Il doit plutôt être remis au point de ramassage concerné, se chargeant du recyclage du matériel électrique et électronique. En vous assurant que ce produit est éliminé correctement, vous favorisez la prévention des conséquences négatives pour l'environnement et la santé humaine qui, sinon, seraient le résultat d'un traitement inapproprié des déchets de ce produit. Pour obtenir plus de détails sur le recyclage de ce produit, veuillez prendre contact avec le bureau municipal de votre région, votre service d'élimination des déchets ménagers ou le magasin où vous avez acheté le produit.



Das Symbol  auf dem Produkt oder seiner Verpackung weist darauf hin, dass dieses Produkt nicht als normaler Haushaltsabfall zu behandeln ist, sondern an einem Sammelpunkt für das Recycling von elektrischen und elektronischen Geräten abgegeben werden muss. Durch Ihren Beitrag zum korrekten Entsorgen dieses Produkts schützen Sie die Umwelt und die Gesundheit Ihrer Mitmenschen. Umwelt und Gesundheit werden durch falsches Entsorgen gefährdet. Weitere Informationen über das Recycling dieses Produkts erhalten Sie von Ihrem Rathaus, Ihrer Müllabfuhr oder dem Geschäft, in dem Sie das Produkt gekauft haben.



Ürün veya paketi üzerindeki  sembolü, bu ürünün normal bir evsel atık olarak görülmemesi ve bu tip elektrikli veya elektronik cihazların atıldığı dönüşümlü toplama noktalarına terkedilmesi gerektiğine işaret eder. Bu ürünü gerektiği gibi elimine etme kurallarına uyarmanız çevre ve insan sağlığı üzerindeki olumsuz etkilerini bertaraf etmeye katkı sağlamış olursunuz. Bu ürünün geri dönüşüm koşulları hakkında daha ayrıntılı bilgi için hudutları içinde bulunduğunuz belediyenin ilgili diariesine, atık yoketme servisine veya ürünün satıcısına danışınız.

Franke S.p.a.
Via Pignolini,2
37019 Peschiera del Garda (VR)
www.franke.it